

# JIAXING HARLEY BABY CAR CO., LTD.

## TEST REPORT

### SCOPE OF WORK:

EMC directive (2014/30/EU) – EMC report

### Model:

HL318

### REPORT NUMBER

190300479SHA-001

### ISSUE DATE

March 19, 2019

### DOCUMENT CONTROL NUMBER

TTRF55014-01\_V1

© 2018 Intertek



Report no. 190300479SHA-001

**Applicant** : JIAXING HARLEY BABY CAR CO., LTD.  
NO.123, JINSHA ROAD, XINCANG TOWN, PINGHU CITY, ZHEJIANG PROVINCE, CHINA

**Manufacturer** : JIAXING HARLEY BABY CAR CO., LTD.  
NO.123, JINSHA ROAD, XINCANG TOWN, PINGHU CITY, ZHEJIANG PROVINCE, CHINA

**Manufacturing site** : JIAXING HARLEY BABY CAR CO., LTD.  
NO.123, JINSHA ROAD, XINCANG TOWN, PINGHU CITY, ZHEJIANG PROVINCE, CHINA

### Summary

The equipment complies with the requirements according to the following standard(s) or Specification:

**EN 55014-1:2017:** Electromagnetic compatibility - Requirements for household appliances, electric tools and similar apparatus Part 1: Emission

**EN 55014-1: 2006+A1: 2009/+A2:2011:** Electromagnetic compatibility - Requirements for household appliances, electric tools and similar apparatus Part 1: Emission

**EN 55014-2:2015:** Electromagnetic compatibility - Requirements for household appliances, electric tools and similar apparatus Part 2: Immunity – Product family standard

**EN 61000-3-2:2014:** Electromagnetic compatibility (EMC) - Part 3-2: Limits - Limits for harmonic current emissions (equipment input current  $\leq 16A$  per phase)

**EN 61000-3-3:2013:** Electromagnetic compatibility (EMC) - Part 3-3: Limits - Limitation of voltage changes, voltage fluctuations and flicker in public low-voltage supply systems, for equipment with rated current  $\leq 16A$  per phase and not subject to conditional connection

**PREPARED BY:**

**REVIEWED BY:**



Mark Shen  
Project Engineer



Daniel Zhao  
Reviewer

This report is for the exclusive use of Intertek's Client and is provided pursuant to the agreement between Intertek and its Client. Intertek's responsibility and liability are limited to the terms and conditions of the agreement. Intertek assumes no liability to any party, other than to the Client in accordance with the agreement, for any loss, expense or damage occasioned by the use of this report. Only the Client is authorized to permit copying or distribution of this report and then only in its entirety. Any use of the Intertek name or one of its marks for the sale or advertisement of the tested material, product or service must first be approved in writing by Intertek. The observations and test results in this report are relevant only to the sample tested. This report by itself does not imply that the material, product, or service is or has ever been under an Intertek certification program.

## Contents

<b>REVISION HISTORY.....</b>	<b>5</b>
<b>MEASUREMENT RESULT SUMMARY.....</b>	<b>6</b>
<b>1. GENERAL INFORMATION .....</b>	<b>7</b>
1.1 DESCRIPTION OF EQUIPMENT UNDER TEST (EUT) .....	7
1.2 DESCRIPTION OF TEST FACILITY .....	8
<b>2. TEST SPECIFICATIONS.....</b>	<b>9</b>
2.1 NORMATIVE STANDARDS.....	9
2.2 MODE OF OPERATION DURING THE TEST.....	10
2.3 TEST PERIPHERALS USED .....	10
2.4 RECORD OF CLIMATIC CONDITIONS .....	10
2.5 INSTRUMENT LIST .....	11
2.6 MEASUREMENT UNCERTAINTY .....	13
<b>EMISSION TEST .....</b>	<b>14</b>
<b>3. MAINS/LOAD/CONTROL TERMINAL CONTINUOUS DISTURBANCE VOLTAGE.....</b>	<b>14</b>
3.1 TERMINAL VOLTAGE LIMITS FOR THE FREQUENCY RANGE 9KHZ TO 30MHZ .....	14
3.1.1 <i>General limits</i> .....	14
3.1.2 <i>Limits for mains port of tools</i> .....	14
3.2 BLOCK DIAGRAM OF TEST SETUP .....	15
3.3 TEST SETUP AND TEST PROCEDURE .....	16
3.4 TEST PROTOCOL.....	17
<b>4. MAINS TERMINAL DISCONTINUOUS DISTURBANCE VOLTAGE/CLICK .....</b>	<b>20</b>
4.1 BLOCK DIAGRAM OF TEST SETUP .....	20
4.2 TEST SETUP AND TEST PROCEDURE .....	20
4.3 TEST PROTOCOL.....	21
<b>5. CONTINUOUS DISTURBANCE POWER .....</b>	<b>22</b>
5.1 CONTINUOUS DISTURBANCE POWER LIMIT.....	22
5.2 BLOCK DIAGRAM OF TEST SET UP .....	22
5.3 TEST PROCEDURE.....	22
5.4 TEST PROTOCOL.....	23
<b>6. RADIATED EMISSION .....</b>	<b>25</b>
6.1 LIMIT .....	25
6.2 BLOCK DIAGRAM AND TEST SET UP .....	25
6.3 TEST PROTOCOL.....	26
<b>7. HARMONICS.....</b>	<b>28</b>
7.1 BLOCK DIAGRAM OF TEST SETUP .....	28
7.2 TEST SETUP AND TEST PROCEDURE .....	28
7.3 TEST PROTOCOL.....	29
<b>8. VOLTAGE FLUCTUATIONS-FLICKER.....</b>	<b>30</b>
8.1 BLOCK DIAGRAM OF TEST SETUP .....	30
8.2 TEST SETUP AND TEST PROCEDURE .....	30
8.2.1 <i>Definition</i> .....	30
8.2.2 <i>Test condition</i> .....	30
8.3 TEST PROTOCOL.....	31
<b>IMMUNITY TEST .....</b>	<b>32</b>

**9. ELECTROSTATIC DISCHARGE (ESD)..... 33**

9.1 SEVERITY LEVEL AND PERFORMANCE CRITERION..... 33

    9.1.1 *Test level* ..... 33

    9.1.2 *Performance Criterion*..... 33

9.2 BLOCK DIAGRAM OF TEST SETUP ..... 34

9.3 TEST SETUP AND TEST PROCEDURE ..... 35

9.4 TEST PROTOCOL ..... 36

**10. ELECTROMAGNETIC FIELD SUSCEPTIBILITY .....37**

10.1 SEVERITY LEVEL AND PERFORMANCE CRITERION ..... 37

    10.1.1 *Test level*..... 37

    10.1.2 *Performance Criterion* ..... 37

10.2 BLOCK DIAGRAM OF TEST SETUP ..... 38

10.3 TEST SETUP AND TEST PROCEDURE ..... 38

10.4 TEST PROTOCOL ..... 38

**11. ELECTRIC FAST TRANSIENT/BURST IMMUNITY TEST ..... 39**

11.1 SEVERITY LEVEL AND PERFORMANCE CRITERION ..... 39

    11.1.1 *Test level*..... 39

    11.1.2 *Performance Criterion* ..... 39

11.2 BLOCK DIAGRAM OF TEST SETUP ..... 40

    11.2.1 *Block Diagram for input a.c./d.c. power line*..... 40

    11.2.2 *Block Diagram for output a.c./d.c. power line or signal/control lines*..... 41

11.3 TEST SETUP AND TEST PROCEDURE ..... 41

11.4 TEST PROTOCOL ..... 42

**12. SURGE IMMUNITY TEST ..... 43**

12.1 SEVERITY LEVEL AND PERFORMANCE CRITERION ..... 43

    12.1.1 *Test level*..... 43

    12.1.2 *Performance Criterion* ..... 43

12.2 BLOCK DIAGRAM OF TEST SETUP ..... 44

12.3 TEST SETUP AND TEST PROCEDURE ..... 44

12.4 TEST PROTOCOL ..... 44

**13. IMMUNITY TO CONDUCTED DISTURBANCES, INDUCED BY RADIO-FREQUENCY FIELDS..... 45**

13.1 SEVERITY LEVEL AND PERFORMANCE CRITERION ..... 45

    13.1.1 *Test level*..... 45

    13.1.2 *Performance Criterion* ..... 45

13.2 BLOCK DIAGRAM OF TEST SETUP ..... 45

13.3 TEST SETUP AND TEST PROCEDURE ..... 46

13.4 TEST PROTOCOL ..... 47

**14. VOLTAGE DIPS, SHORT INTERRUPTIONS AND VOLTAGE VARIATIONS IMMUNITY TEST ..... 48**

14.1 SEVERITY LEVEL AND PERFORMANCE CRITERION ..... 48

    14.1.1 *Test level*..... 48

    14.1.2 *Performance Criterion* ..... 48

14.2 BLOCK DIAGRAM OF TEST SETUP ..... 49

14.3 TEST SETUP AND TEST PROCEDURE ..... 49

14.4 TEST PROTOCOL ..... 49

**APPENDIX I: PHOTOGRAPH OF EQUIPMENT UNDER TEST ..... 50**

### Revision History

Report No.	Version	Description	Issued Date
190300479SHA-001	Rev. 01	Initial issue of report	March 19, 2019

## Measurement result summary

TEST ITEM	TEST RESULT	NOTE
Mains terminal continuous disturbance voltage	Pass	
Mains terminal discontinuous disturbance voltage/click	NA	
Continuous disturbance power	Pass	
Radiated Emission	Pass	
Harmonics	Pass	
Voltage fluctuation-Flicker	Pass	
Electrostatic Discharge (ESD)	Pass	
RF electromagnetic field susceptibility	Pass	
Electric Fast Transient /Burst (EFT/B)	Pass	
Surge	Pass	
Injected Current	Pass	
Voltage dips and interruption	Pass	

**Notes:**

1. NA =Not Applicable
2. Determination of the test conclusion is based on IEC Guide 115 in consideration of measurement uncertainty.
3. Additions, Deviations and Exclusions from Standards: None.

## 1. GENERAL INFORMATION

### 1.1 Description of Equipment Under Test (EUT)

Product name : Children Car

Type/Model : HL318

Brand name : -

Description of EUT : We tested the model HL318 with the battery chargers: RR-48-1201000D and listed the worst data.

Rating : Battery: 12Vd.c.  
Battery charger:  
Input: 220~240VAC~, 50Hz, 100mA  
Output: 12VDC, 1A

Highest operating frequency : <108MHz

EUT type :  Table-top  
 Floor standing

EUT is toy, defined as  
 Category A  
 Category B  
 Category C  
 Category D  
 Category E

Sample received date : March 6, 2019

Sample Identification No. : 0190306-31

Date of test : March 6, 2019~ March 15, 2019

## 1.2 Description of Test Facility

Name : Intertek Testing Services Shanghai

Address : Building 86, No. 1198 Qinzhou Road(North), Shanghai 200233, P.R. China

Telephone : 86 21 61278200

Telefax : 86 21 54262353

The test facility is recognized, certified, or accredited by these organizations :

- CNAS Accreditation Lab  
Registration No. CNAS L0139
- FCC Accredited Lab  
Designation Number: CN0051
- IC Registration Lab  
Registration code No.: 2042B-1
- VCCI Registration Lab  
Registration No.: R-14243, G-10845, C-14723, T-12252
- A2LA Accreditation Lab  
Certificate Number: 3309.02



## 2. TEST SPECIFICATIONS

### 2.1 Normative Standards

IEC 61000-4-2:2008: Electromagnetic Compatibility (EMC) – Part 4-2: testing and measurement techniques – electrostatic discharge immunity test

IEC 61000-4-3:2006+A1:2007+A1:2010: Electromagnetic Compatibility (EMC) – Part 4-3: testing and measurement techniques – radiated, radio frequency, electromagnetic field immunity test

IEC 61000-4-4:2012: Electromagnetic Compatibility (EMC) – Part 4-4: testing and measurement techniques – electric fast transient/burst immunity test

IEC 61000-4-5:2014: Electromagnetic Compatibility (EMC) – Part 4-5: testing and measurement techniques – section 5: surge immunity test

IEC 61000-4-6:2013: Electromagnetic Compatibility (EMC) – Part 4-6: testing and measurement techniques – section 6: immunity to conducted disturbance, induced by radio frequency field

IEC 61000-4-11:2004: Electromagnetic Compatibility (EMC) – Part 4-11: testing and measurement techniques –voltage dips, short interruption and voltage variations immunity test

IEC 61000-4-22:2010, Electromagnetic compatibility (EMC) – Part 4-22: Testing and measurement techniques – Radiated emissions and immunity measurements in fully anechoic rooms (FARs)

**Note: there are no magnetic sensitive components included in this EUT and magnetic field immunity test according to EN 61000-4-8 is therefore not required.**

## 2.2 Mode of operation during the test

Within this test report, EUT was tested under all available operation modes and tested under its rating voltage and frequency. Other voltage and frequency is specified if used.

## 2.3 Test Peripherals used

Item No	Description	Band and Model	S/No
1	-	-	-

## 2.4 Record of climatic conditions

Test Item	Temperature (°C)	Relative Humidity (%)	Pressure (Kpa)
Mains terminal continuous disturbance voltage	24	48	101
Mains terminal discontinuous disturbance voltage/click	NA	NA	NA
Continuous disturbance power	24	48	101
Radiated Emission	27	52	101
Harmonics	NA	NA	NA
Voltage fluctuation-Flicker	NA	NA	NA
Electrostatic Discharge (ESD)	26	55	101
RF electromagnetic field susceptibility	27	52	101
Electric Fast Transient /Burst (EFT/B)	26	55	101
Surge	26	55	101
Injected Current	22	49	101
Voltage dips and interruption	26	55	101

Notes: NA =Not Applicable

## 2.5 Instrument list

Conducted Emission / Disturbance Power / Tri-loop Test / CDN method					
Used	Equipment	Manufacturer	Type	Internal no.	Due date
<input checked="" type="checkbox"/>	Test Receiver	R&S	ESCS 30	EC 2107	2019-07-15
<input checked="" type="checkbox"/>	A.M.N.	R&S	ESH2-Z5	EC 3119	2019-11-30
<input checked="" type="checkbox"/>	Absorbing clamp	R&S	MDS 21	EC 2108	2019-06-19
<input checked="" type="checkbox"/>	Shielded room	Zhongyu	-	EC 2838	2020-01-14
Radiated Emission					
Used	Equipment	Manufacturer	Type	Internal no.	Due date
<input checked="" type="checkbox"/>	Test Receiver	R&S	ESIB 26	EC 3045	2019-09-13
<input checked="" type="checkbox"/>	Bilog Antenna	TESEQ	CBL 6112D	EC 4206	2019-06-10
<input checked="" type="checkbox"/>	Semi-anechoic chamber	Albatross project	-	EC 3048	2019-07-31
ESD					
Used	Equipment	Manufacturer	Type	Internal no.	Due date
<input checked="" type="checkbox"/>	ESD generator	TESEQ	NSG 437	EC 4792-4	2019-03-22
<input checked="" type="checkbox"/>	Shielded room	Zhongyu	-	EC 2839	2020-01-14
EFT / Surge / Voltage Dips					
Used	Equipment	Manufacturer	Type	Internal no.	Due date
<input checked="" type="checkbox"/>	Conduct immunity system	EM TEST	UCS 500M6B	EC 2958	2019-04-07
<input checked="" type="checkbox"/>	Automatic transformer	EM TEST	MV2616	EC 2957	2019-04-07
<input checked="" type="checkbox"/>	Shielded room	Zhongyu	-	EC 2839	2020-01-14
Conducted Immunity					
Used	Equipment	Manufacturer	Type	Internal no.	Due date
<input checked="" type="checkbox"/>	Signal generator	R&S	SML 01	EC 2338	2019-09-11
<input checked="" type="checkbox"/>	Power amplifier	AR	75A250	EC 3043-1	2019-07-15
<input checked="" type="checkbox"/>	Attenuator	EM TEST	ATT6/75	EC 3043-3	2020-02-11
<input checked="" type="checkbox"/>	CDN	Frankonia	CDN M2M316	EC 5969	2019-03-15
Radiated Immunity					
Used	Equipment	Manufacturer	Type	Internal no.	Due date
<input checked="" type="checkbox"/>	Signal generator	R&S	SMR 20	EC 3044-1	2020-01-14
<input checked="" type="checkbox"/>	Power amplifier	AR	250W1000B	EC 5818-2	2019-04-19
<input checked="" type="checkbox"/>	Power amplifier	BONN	BLMA1060-100	EC 5818-4	2019-04-19
<input checked="" type="checkbox"/>	Log-period antenna	AR	AT 1080	EC 3044-7	2020-01-02
<input checked="" type="checkbox"/>	Fully-anechoic chamber	Albatross project	-	EC 3047	2019-07-31
Additional instrument					
Used	Equipment	Manufacturer	Type	Internal no.	Due date

<input checked="" type="checkbox"/>	Therom-Hygrograph	ZJ1-2A	S.M.I.F.	EC 3783	2020-02-27
<input checked="" type="checkbox"/>	Therom-Hygrograph	ZJ1-2A	S.M.I.F.	EC 2122	2019-03-11
<input checked="" type="checkbox"/>	Therom-Hygrograph	ZJ1-2A	S.M.I.F.	EC 5198	2020-01-17
<input checked="" type="checkbox"/>	Therom-Hygrograph	ZJ1-2A	S.M.I.F.	EC 3326	2019-03-28
<input checked="" type="checkbox"/>	Pressure meter	YM3	Shanghai Mengde	EC 3320	2019-07-01

## 2.6 Measurement Uncertainty

Measurement	Frequency	Expanded Uncertainty (k=2) (±)
Conducted emission at mains ports	9kHz ~ 150kHz	3.71 dB
	150kHz ~ 30MHz	3.31 dB
Continuous disturbance voltage at telecom port with AAN	150kHz ~ 30MHz	4.10 dB
Continuous disturbance current at telecom ports	150kHz ~ 30MHz	2.73 dB
Mains terminal discontinuous disturbance voltage/click	-	3.87 dB
Continuous disturbance power	30MHz ~ 300MHz	4.42 dB
Radiated Emissions up to 1 GHz	30MHz ~ 1GHz	5.04 dB
Radiated Emissions above 1 GHz	1GHz ~ 6GHz	4.97 dB
	6GHz ~ 18GHz	5.29 dB
Harmonic current emission	-	3.90%
Voltage fluctuations and flicker	-	10.34%
ESD	-	6.65%
Radiated susceptibility	-	2.38%
EFT test at main terminal	-	11.57%
EFT test at signal/telecom terminal	-	11.62%
Surge test at main terminal	-	11.57%
Injected current test at main terminal	-	1.88 dB
Injected current test at unshielded signal terminal	-	3.41 dB
Voltage dips and interruption	-	6.05%

## Emission Test

### 3. Mains/Load/Control Terminal Continuous Disturbance Voltage

**Test result:                      PASS**

#### 3.1 Terminal Voltage Limits for the frequency range 9kHz to 30MHz

##### 3.1.1 General limits

Frequency range (MHz)	Mains ports		Associated ports			
	Disturbance voltage		Disturbance voltage		Disturbance current	
	Limits dB(μV) Quasi-peak    Average		Limits dB(μV) Quasi-peak    Average		Limits dB(μV) Quasi-peak    Average	
0.15 ~ 0.5	66 ~ 56 *	59 ~ 46 *	80	70	40 ~ 30 *	30 ~ 20 *
0.5 ~ 5.0	56	46	74	64	30	20
5.0 ~ 30	60	50	74	64		

Notes:  
 1. \* means the limit decreasing linearly with the logarithm of the frequency in the range 0.15MHz to 0.5MHz.  
 2. If the quasi-peak measurements meet the average limit, the EUT shall be deemed to meet both limits and the measurements using the average detector need not be carried out.

##### 3.1.2 Limits for mains port of tools

Frequency range (MHz)	P ≤ 700 W		700 W < P ≤ 1 000 W		P > 1 000 W	
	Limits dB(μV)		Limits dB(μV)		Limits dB(μV)	
	Quasi-peak	Average	Quasi-peak	Average	Quasi-peak	Average
0.15-0.35	66-59*	59-49*	70-63*	63-53*	76-69*	69 ~ 59 *
0.35-5	59	49	63	53	69	59
5-30	64	54	68	58	74	64

Notes:  
 1. \* means the limit decreasing linearly with the logarithm of the frequency in the range 0.15MHz to 0.35MHz.  
 2. If the quasi-peak measurements meet the average limit, the EUT shall be deemed to meet both limits and the measurements using the average detector need not be carried out.

### 3.2 Block Diagram of Test Setup

At mains terminal

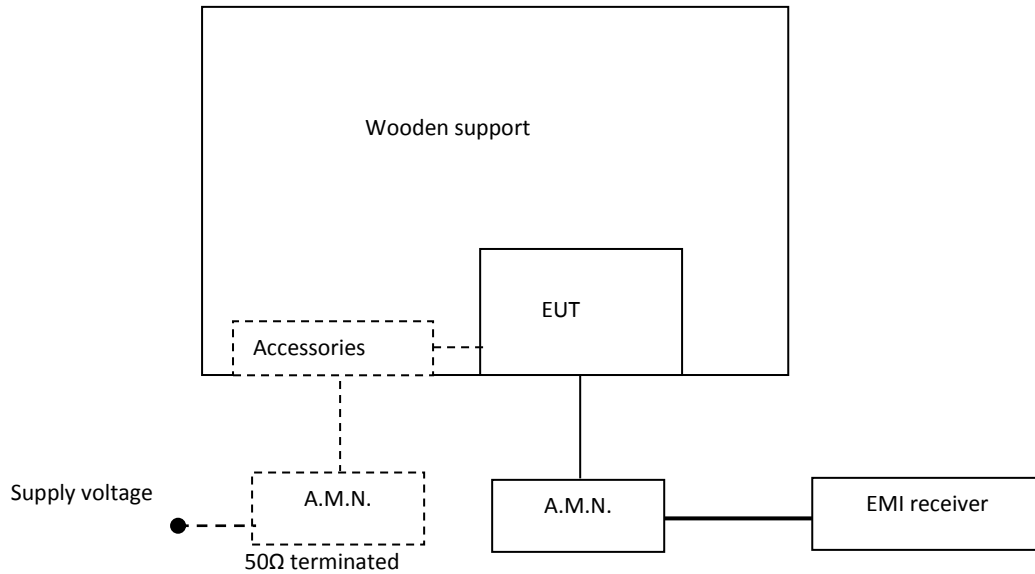

For table top equipment, wooden support is 0.8m height table

For floor standing equipment, wooden support is 0.1m height rack.

At Associated ports

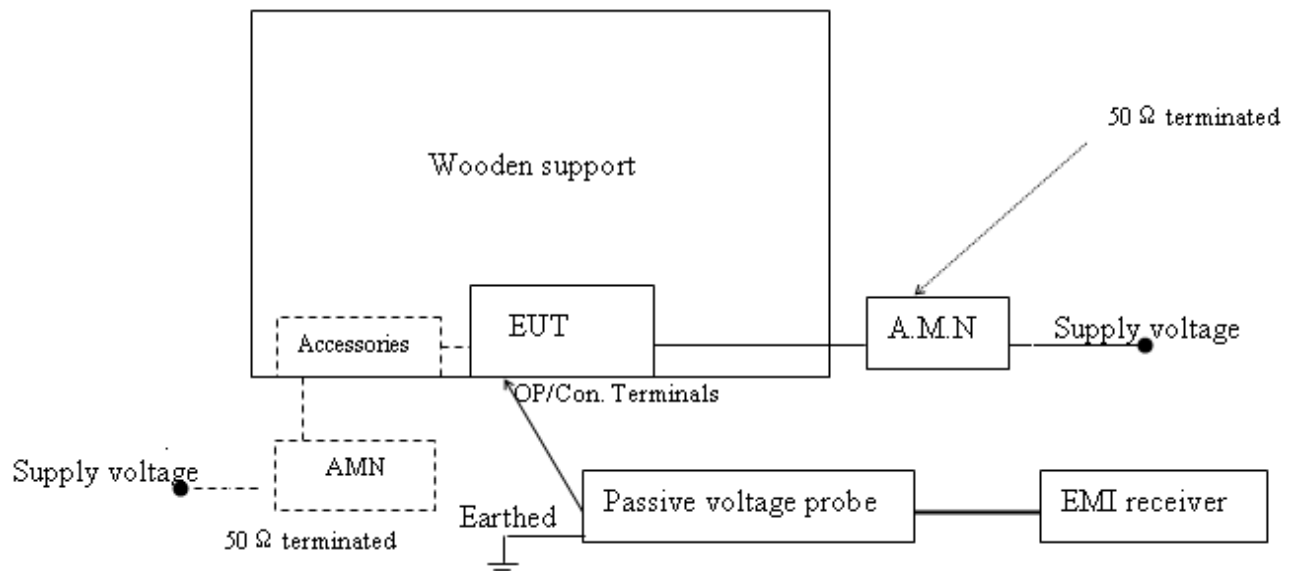

Note:   
 ————— : power line  
 ————— : signal line  
 - - - - - : means the test setup while available

### **3.3 Test Setup and Test Procedure**

Measurement was performed in shielded room, and instruments used were according to clause 5.1 of EN 55014-1 if applicable.

Detailed test procedure and arrangement was according to clause 5.2 of EN 55014-1.

Measurement methods was according to clause 5.4 of EN 55014-1.

Operation conditions of EUT was according to clause 6 of EN 55014-1.

Frequency range 150kHz – 30MHz was checked and EMI receiver measurement bandwidth was set to 9kHz.



### 3.4 Test Protocol

For Mains ports: Pass

L-Line:

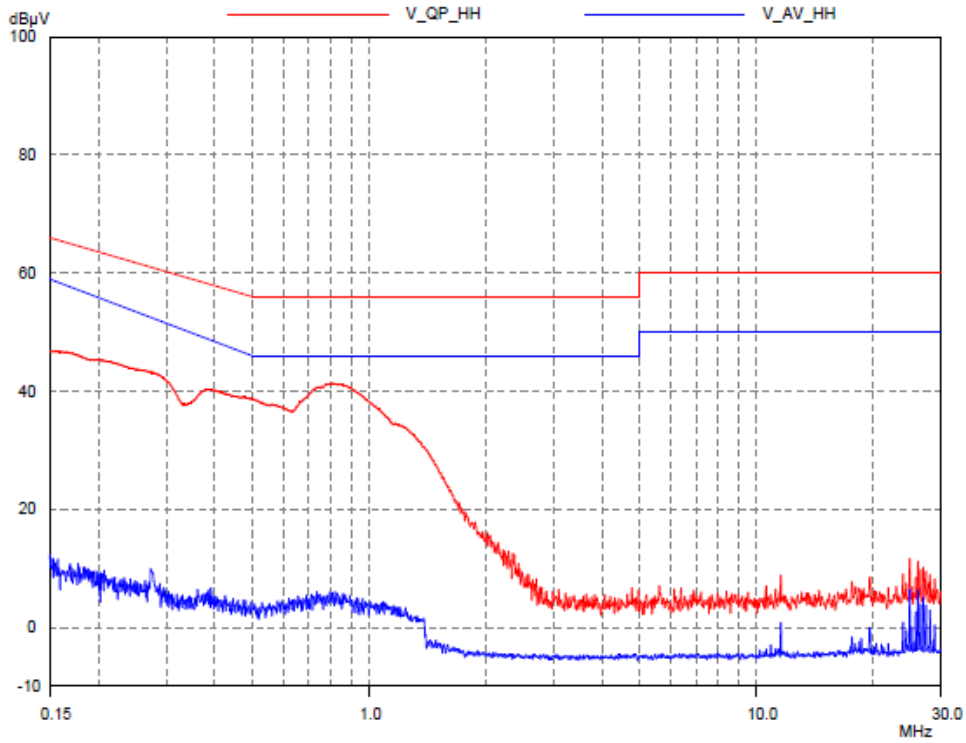

Frequency (MHz)	Quasi-peak			Average		
	Corrected Reading (dBµV)	Limit (dBµV)	Margin (dB)	Corrected Reading (dBµV)	Limit (dBµV)	Margin (dB)
0.16	*	65.30	*	*	58.10	*
0.24	*	62.40	*	*	54.40	*
0.50	*	56.00	*	*	46.00	*
1.40	*	56.00	*	*	46.00	*
2.00	*	56.00	*	*	46.00	*
3.50	*	56.00	*	*	46.00	*
6.00	*	60.00	*	*	50.00	*
10.00	*	60.00	*	*	50.00	*

Note: \* means the emission level 10dB below the relevant limit.

N-Line:

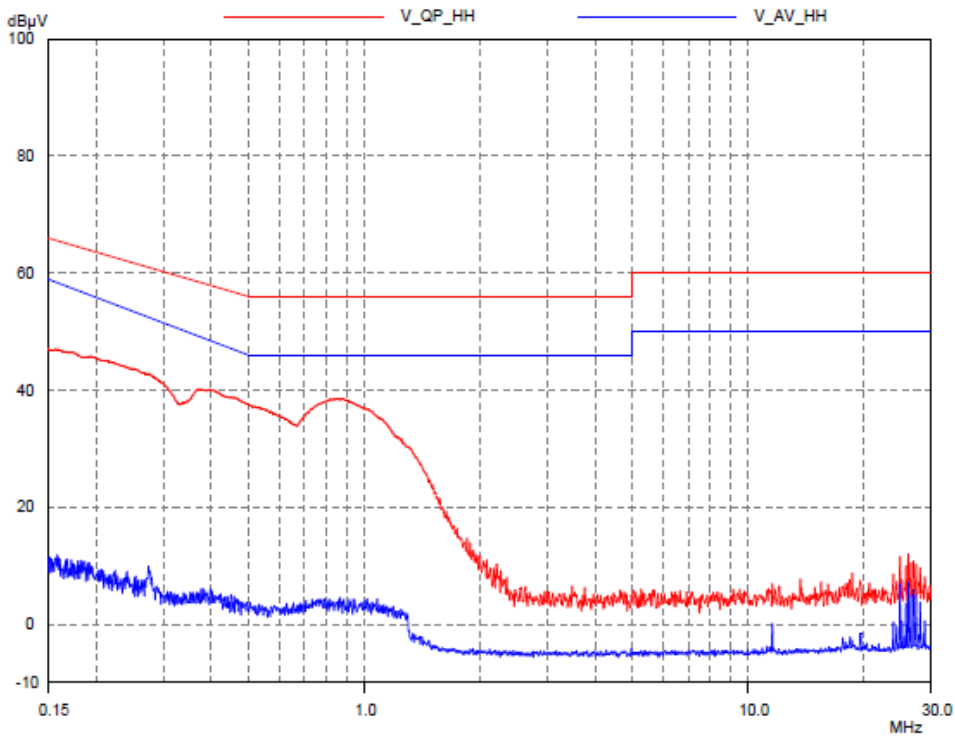

Frequency (MHz)	Quasi-peak			Average		
	Corrected Reading (dBuV)	Limit (dBuV)	Margin (dB)	Corrected Reading (dBuV)	Limit (dBuV)	Margin (dB)
0.16	*	65.30	*	*	58.10	*
0.24	*	62.40	*	*	54.40	*
0.50	*	56.00	*	*	46.00	*
1.40	*	56.00	*	*	46.00	*
2.00	*	56.00	*	*	46.00	*
3.50	*	56.00	*	*	46.00	*
6.00	*	60.00	*	*	50.00	*
10.00	*	60.00	*	*	50.00	*

Note: \* means the emission level 10dB below the relevant limit.

- Remark: 1. Correct Factor = LISN Factor + Cable Loss, the value was added to Original Receiver Reading by the software automatically.  
 2. Corrected Reading = Original Receiver Reading + Correct Factor  
 3. Margin = Limit - Corrected Reading  
 4. If the PK Corrected Reading is lower than AV limit, the AV test can be elided.

Example: Assuming LISN Factor = 10.00dB, Cable Loss = 2.00dB,  
 Original Receiver Reading = 10.00dBuV, Limit = 66.00dBuV.  
 Then Correct Factor = 10.00 + 2.00 = 12.00dB;  
 Corrected Reading = 10dBuV + 12.00dB = 22.00dBuV;  
 Margin = 66.00dBuV – 22.00dBuV = 44.00dB.

**For Associated ports: NA**

Frequency (MHz)	Quasi-peak			Average		
	Corrected Reading (dBuV)	Limit (dBuV)	Margin (dB)	Corrected Reading (dBuV)	Limit (dBuV)	Margin (dB)
Note: * means the emission level 20dB below the relevant limit.						

- Remark:
1. Correct Factor = LISN Factor + Cable Loss, the value was added to Original Receiver Reading by the software automatically.
  2. Corrected Reading = Original Receiver Reading + Correct Factor
  3. Margin = Limit - Corrected Reading
  4. If the PK Corrected Reading is lower than AV limit, the AV test can be elided.

Example: Assuming LISN Factor = 10.00dB, Cable Loss = 2.00dB,  
 Original Receiver Reading = 10.00dBuV, Limit = 66.00dBuV.  
 Then Correct Factor = 10.00 + 2.00 = 12.00dB;  
 Corrected Reading = 10dBuV + 12.00dB = 22.00dBuV;  
 Margin = 66.00dBuV – 22.00dBuV = 44.00dB.

## 4. Mains terminal discontinuous disturbance voltage/click

Test result: NA

### 4.1 Block Diagram of Test Setup

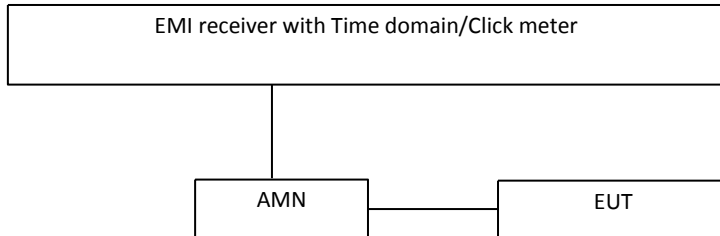

### 4.2 Test Setup and Test Procedure

Measurement was performed in shielded room, and instruments used were according to clause 5.1 of EN 55014-1 if applicable.

Detailed test procedure and arrangement was according to clause 5.2 of EN 55014-1.

Measurement methods was according to clause 5.4 of EN 55014-1.

Operation conditions of EUT was according to clause 6 of EN 55014-1.

0.15MHz, 0.5MHz, 1.4MHz and 30MHz were spot checked, and upper quartile methods used during measurement.

The final judgment of test result was according to figure 6 of EN 55014-1.

**4.3 Test Protocol**

Frequency (MHz)	0.15	0.5	1.4	30.0
Permitted limit for continuous interference (dB $\mu$ V)	66.0	56.0	56.0	60.0
Counted click/switch operation number				
Observed time (min)				
Click duration (ms)				
Click rate N				
Factor				
Permitted limits for clicks (dB $\mu$ v)				
Counted clicks exceeding the limits				
Test result				
Any other descriptions:				

## 5. Continuous disturbance power

Test result: Pass

### 5.1 Continuous disturbance power limit

Frequency range (MHz)	General		$P \leq 700 \text{ W}$		$700 \text{ W} < P \leq 1\,000 \text{ W}$		$P > 1\,000 \text{ W}$	
	Limits dB( $\mu\text{V}$ )		Limits dB( $\mu\text{V}$ )		Limits dB( $\mu\text{V}$ )		Limits dB( $\mu\text{V}$ )	
	Quasi-peak	Average	Quasi-peak	Average	Quasi-peak	Average	Quasi-peak	Average
30-300	45-55*	35-45*	45-55*	35-45*	49-59*	39-49*	55-65*	45-55*

Notes:

- \* means the limit decreasing linearly with the logarithm of the frequency in the range 30MHz to 300MHz.
- If the quasi-peak measurements meet the average limit, the EUT shall be deemed to meet both limits and the measurements using the average detector need not be carried out.

### 5.2 Block diagram of test set up

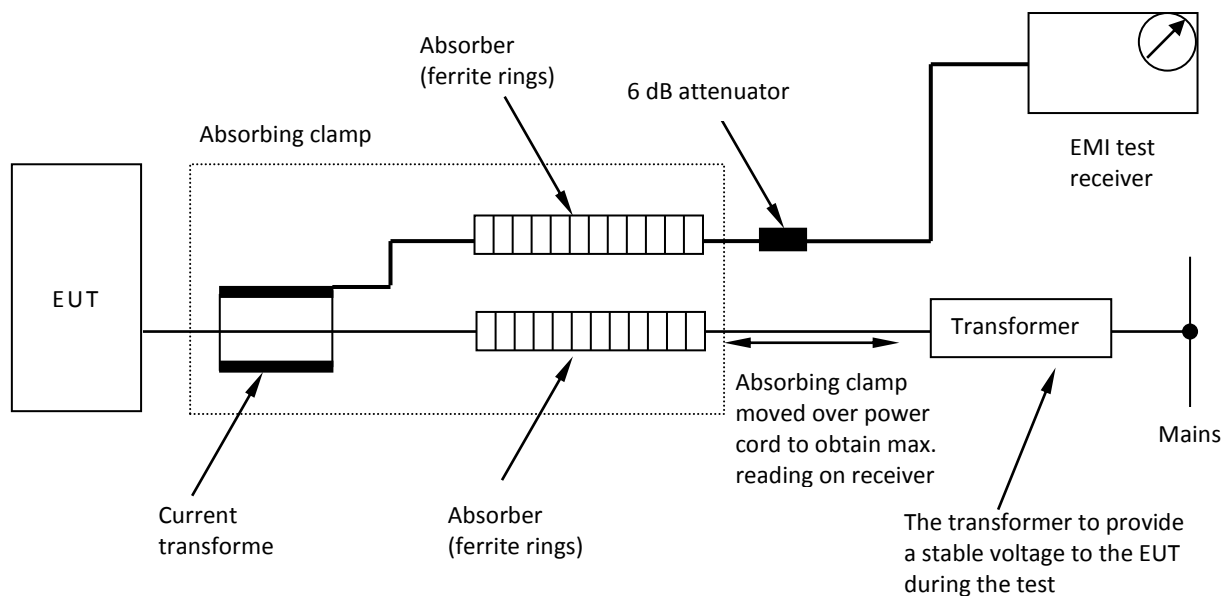

### 5.3 Test Procedure

Measurement was performed in shielded room, and instruments used were according to clause 5.1 of EN 55014-1 if applicable.

Detailed test procedure and arrangement was according to clause 5.3 of EN 55014-1.

Measurement methods was according to clause 5.4 of EN 55014-1.

Operation conditions of EUT was according to clause 6 of EN 55014-1.

Frequency range 30MHz – 300MHz was checked and EMI receiver measurement bandwidth was set to 120kHz.

**5.4 Test Protocol**

**For Mains ports: Pass**

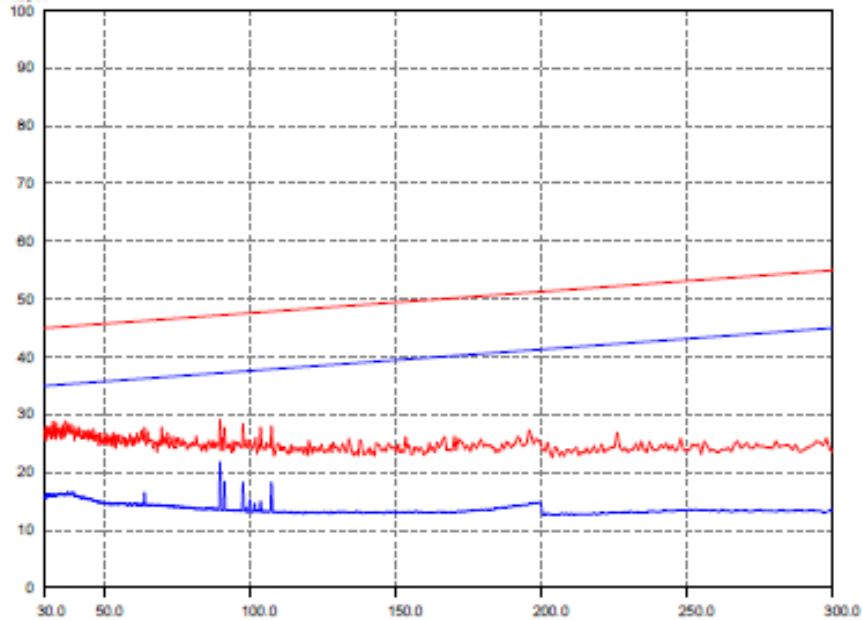

Frequency (MHz)	Quasi-peak			Average		
	Corrected Reading (dBuV)	Limit (dBuV)	Margin (dB)	Corrected Reading (dBuV)	Limit (dBuV)	Margin (dB)
30.00	*	45.0	*	*	35.0	*
35.05	*	45.2	*	*	35.2	*
65.00	*	46.3	*	*	36.3	*
90.00	*	47.2	*	*	37.2	*
180.00	*	50.6	*	*	40.6	*
220.00	*	52.0	*	*	42.0	*
300.00	*	55.0	*	*	45.0	*

Note: \* means the emission level 20dB below the relevant limit.

- Remark: 1. Correct Factor = Clamp Factor + Cable Loss, the value was added to Original Receiver Reading by the software automatically.  
 2. Corrected Reading = Original Receiver Reading + Correct Factor  
 3. Margin = Limit - Corrected Reading  
 4. If the PK Corrected Reading is lower than AV limit, the AV test can be elided.

Example: Assuming Clamp Factor = 10.00dB, Cable Loss = 2.00dB,  
 Original Receiver Reading = 10.00dBuV, Limit = 66.00dBuV.  
 Then Correct Factor = 10.00 + 2.00 = 12.00dB;  
 Corrected Reading = 10dBuV + 12.00dB = 22.00dBuV;  
 Margin = 66.00dBuV – 22.00dBuV = 44.00dB.

**For Associated ports: NA**

Frequency (MHz)	Quasi-peak			Average		
	Corrected Reading (dBuV)	Limit (dBuV)	Margin (dB)	Corrected Reading (dBuV)	Limit (dBuV)	Margin (dB)
Note: * means the emission level 20dB below the relevant limit.						

- Remark:
1. Correct Factor = LISN Factor + Cable Loss, the value was added to Original Receiver Reading by the software automatically.
  2. Corrected Reading = Original Receiver Reading + Correct Factor
  3. Margin = Limit - Corrected Reading
  4. If the PK Corrected Reading is lower than AV limit, the AV test can be elided.

Example: Assuming LISN Factor = 10.00dB, Cable Loss = 2.00dB,  
 Original Receiver Reading = 10.00dBuV, Limit = 66.00dBuV.  
 Then Correct Factor = 10.00 + 2.00 = 12.00dB;  
 Corrected Reading = 10dBuV + 12.00dB = 22.00dBuV;  
 Margin = 66.00dBuV – 22.00dBuV = 44.00dB.



## 6. Radiated emission

**Test result: PASS**

As for in the disturbance power test all emission readings from the EUT are lower than the applicable limits (Table 7) reduced by the margin (Table 8) and the maximum clock frequency is less than 30MHz, the EUT is deemed to comply with the Radiated Emission requirement without test.

### 6.1 Limit

Radiated emission limit from frequency range 30MHz – 1000MHz

Frequency (MHz)	Permitted limit in dB $\mu$ V/m (Quasi-peak) of Measurement Distance 3m	Permitted limit in dB $\mu$ V/m (Quasi-peak) of Measurement Distance 10m
30 ~ 230	40	30
230 ~ 300	47	37

Notes:

- For the measurement distance other than 3m and 10m, the limit is varied according to 20dB/10 decades.
- The gray rows are selected items.

### 6.2 Block diagram and test set up

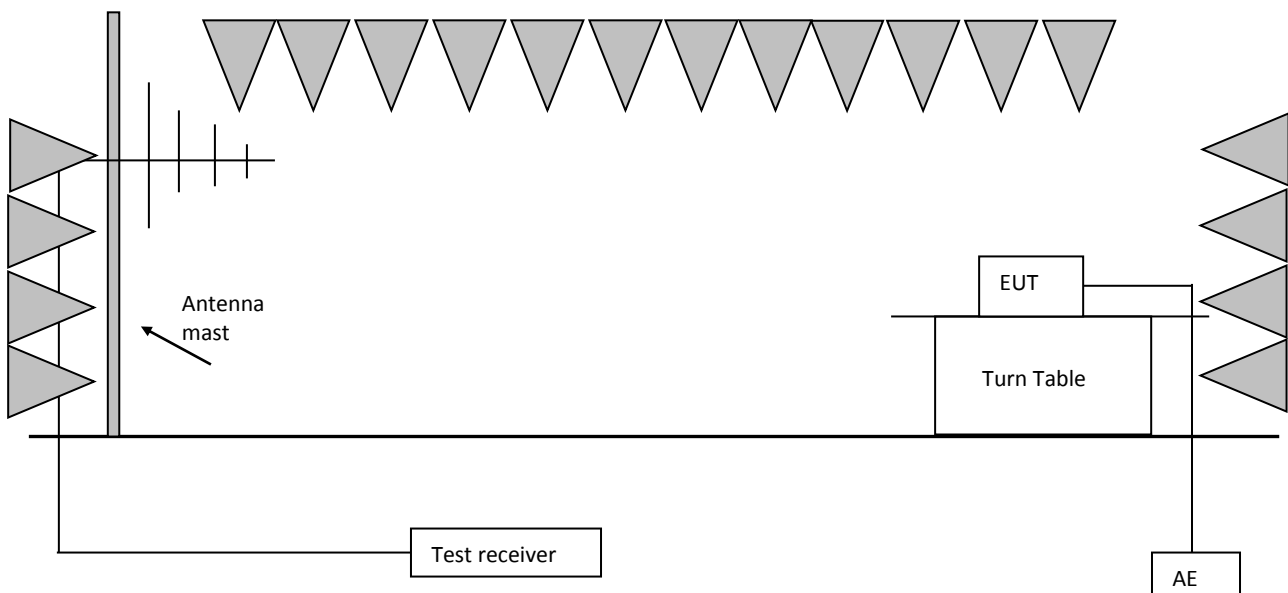

The measurement was applied in a semi-anechoic chamber.  
 Operation conditions of EUT was according to clause 6 of EN 55014-1.  
 Measurement was performed according to clause 10 of CISPR 32.  
 Setting of EUT is according to clause 5.3.4.3 of EN 55014-1.  
 The bandwidth setting on test receiver was 120kHz.  
 The frequency range from 30MHz to 300MHz was checked.

### 6.3 Test Protocol

EUT operating in working normally mode (not in battery charging mode)

Horizontal

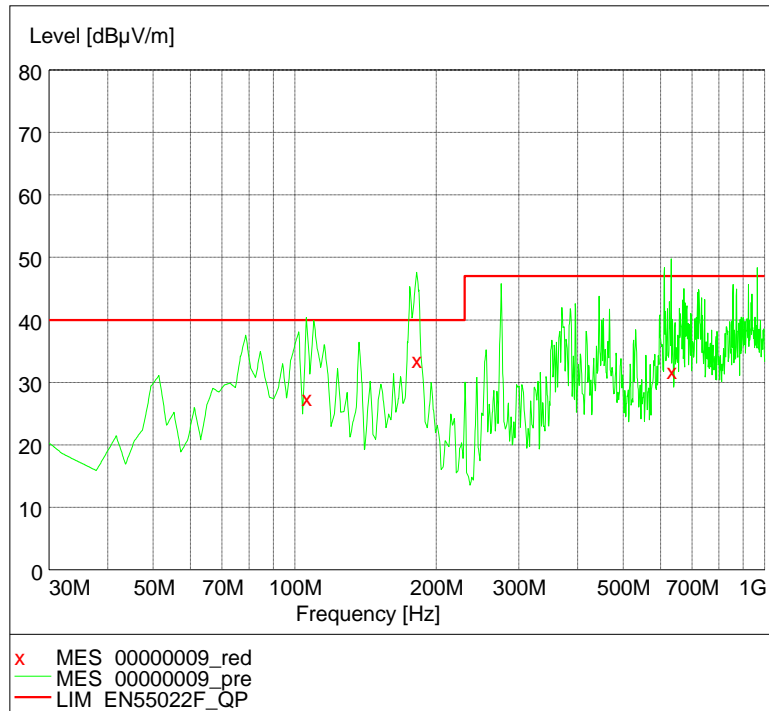

Vertical

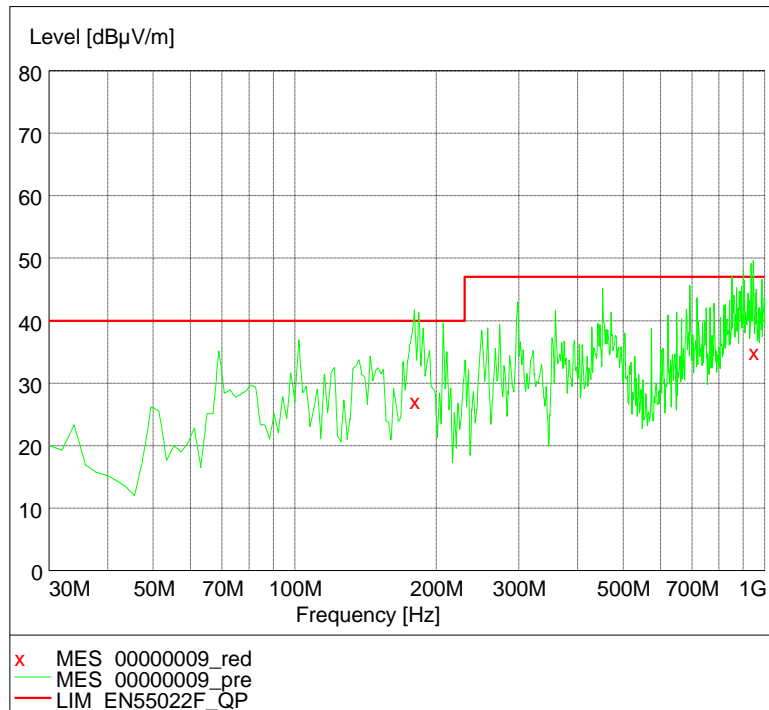

Polarization	Frequency (MHz)	Corrected Reading (dBuV/m)	Limits (dBuV/m)	Margin (dBuV/m)
Horizontal	53.32	*	40.00	*
	105.81	27.20	40.00	12.80
	181.62	33.10	40.00	6.90
	232.16	*	47.00	*
	632.60	30.90	47.00	16.10
	873.64	*	47.00	*
Vertical	73.76	*	40.00	*
	179.76	27.60	40.00	12.40
	220.50	*	40.00	*
	294.36	*	47.00	*
	679.25	34.40	47.00	12.60
	945.57	*	47.00	*

Note: \* means margin >10dB.

- Remark: 1. Corrected Reading = Original Receiver Reading + Correct Factor  
 2. Margin = Limit - Corrected Reading  
 3. If the PK Corrected Reading is lower than AV limit, the AV test can be elided.

Example: Assuming Antenna Factor = 30.20dB/m, Cable Loss = 2.00dB,  
 Gain of Preamplifier = 32.00dB, Original Receiver Reading = 10.00dBuV,  
 Limit = 40.00dBuV/m.  
 Corrected Reading = 10dBuV + 0.20dB/m = 10.20dBuV/m;  
 Margin = 40.00dBuV/m - 10.20dBuV/m = 29.80dB.

## 7. Harmonics

Test result: **PASS**

### 7.1 Block Diagram of Test Setup

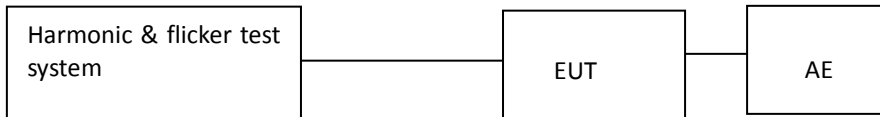

### 7.2 Test Setup and Test Procedure

Harmonics of the fundamental current were measured up to 40 order harmonics using a digital power meter with an analogue output and frequency analyser which was integrated in the harmonic & flicker test system. The measurements were carried out under steady conditions.

- Measuring instrumentation according to IEC 61000-4-7:2002+A1:2008
- This product is not defined as lighting equipment, and has rated power less than 75W, therefore, no limit apply according to EN 61000-3-2
- The EUT is kitchen machines as listed in the scope of IEC 60335-2-14, therefore, is deemed to conform to the harmonic current limits of this standard without further testing.

### 7.3 Test Protocol

## 8. Voltage Fluctuations-Flicker

Test result: **PASS**

### 8.1 Block Diagram of Test Setup

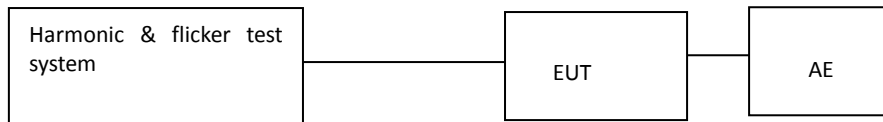

### 8.2 Test Setup and Test Procedure

#### 8.2.1 Definition

Flicker: impression of unsteadiness of visual sensation induced by a light stimulus whose luminance or spectral distribution fluctuates with time.

Pst: Short-term flicker severity.

Plt: long-term flicker severity.

dc: maximum steady state voltage change during an observation period.

dmax: maximum absolute voltage change during an observation period.

d(t): time function of the relative r.m.s. voltage change evaluated as a single value for each successive half period between zero-crossings of the source voltage, except during time interval in which the voltage is a steady-state condition for at least 1s.

#### 8.2.2 Test condition

The EUT was set to produce the most unfavorable sequence of voltage changes.

### 8.3 Test Protocol

The tested object operated under the operating condition specified in EN 61000-3-3  
The following limits apply

- the value of Pst shall not be greater than 1,0.
- the value of Plt shall not be greater than 0,65.
- Tmax, the accumulated time value of d(t) with a deviation exceeding 3,3 % during a single voltage change at the EUT terminals, shall not exceed 500 ms.
- the maximum relative steady-state voltage change, dc, shall not exceed 3,3 %.
- the maximum relative voltage change dmax, shall not exceed:
  - 4% without additional conditions.
  - 6 % for equipment which is:
    - switched manually, or
    - switched automatically more frequently than twice per day, and also has either a delayed restart (the delay being not less than a few tens of seconds), or manual restart, after a power supply interruption.
  - 7 % for equipment which is:
    - attended whilst in use (for example: hair dryers, vacuum cleaners, kitchen equipment such as mixers, garden equipment such as lawn mowers, portable tools such as electric drills), or
    - switched on automatically, or is intended to be switched on manually, no more than twice per day, and also has either a delayed restart (the delay being not less than a few tens of seconds) or manual restart, after a power supply interruption.
  - for manual switch, dmax is measured in accordance with Annex B of standard, average dmax is calculated from 24 times measurement.
  - According to EN 61000-3-3 clause 6.1 & A.2, the EUT is either unlikely to produce significant voltage fluctuations/flicker or no limit and test were required by technical analysis and sample evaluation on the product.

## Immunity Test

### Performance criteria

The performance criteria are based on the general criteria of the standard and derived from the product specification

**Criterion A:** Normal Performance within limits specified by the manufacturer, request or purchaser.

**Criterion B:** Continue to operate as intended after the test. No degradation of performance or loss of function. During the test degradation of performance is allowed, however no change of actual operating state or stored date.

**Criterion C:** Temporary loss of function is allowed, provided the function is self-recoverable or can be restored by the operation of the controls.

### Categories of apparatus

- Category I (fulfill the relevant immunity requirements without testing)
- Category II (Shall fulfill the tests: ESD, EFT, Inject current, Surge, Dips)
- Category III (Shall fulfill the tests: ESD, EM fields\*)
- Category IV (Shall fulfill the tests: ESD, EFT, Inject current, Surge, Dips, EM fields)

Note: \*only applicable to the ride on toys operating with electronic devices.



## 9. Electrostatic Discharge (ESD)

Test result: **PASS**

### 9.1 Severity Level and Performance Criterion

#### 9.1.1 Test level

1a – Contact discharge		1b – Air discharge	
Level	Test voltage kV	Level	Test voltage kV
1	2	1	2
2	4	2	4
3	6	3	8
4	8	4	15
X	Special	X	Special

Notes:

1. "X" is an open level. The level has to be specified in the dedicated equipment specification. If higher voltages than those shown are specified, special test equipment may be needed.
2. The gray rows were the selected test level.

#### 9.1.2 Performance Criterion

Performance criterion: **B**

## 9.2 Block Diagram of Test Setup

For table-top equipment

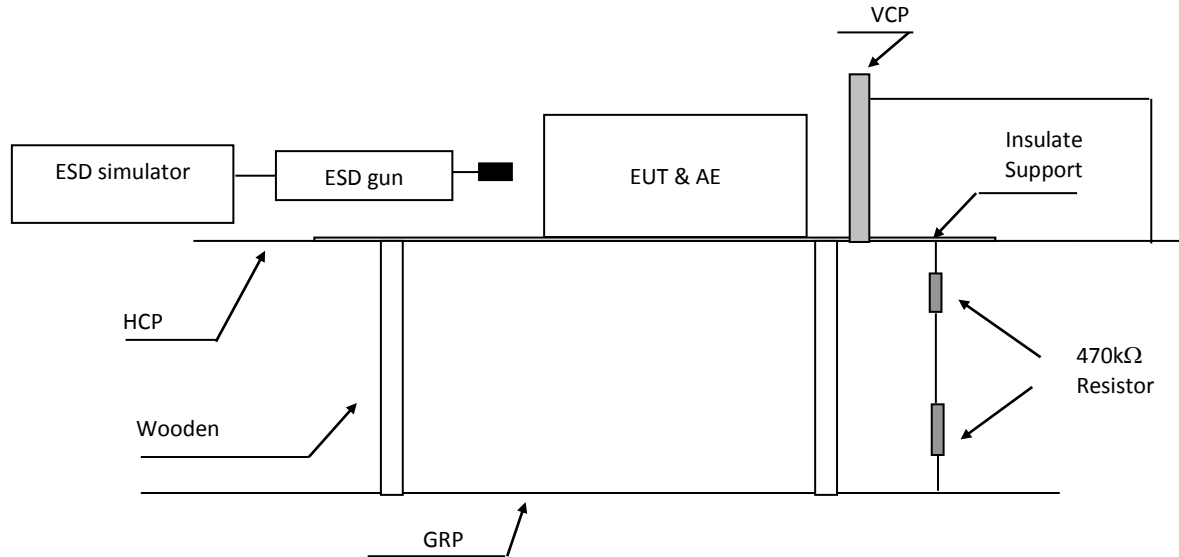

Note: HCP means Horizontal Coupling Plane  
 VCP means Vertical Coupling Plane  
 GRP means Ground Reference Plane  
 Wooden support is a 0.8m height table

For floor standing equipment

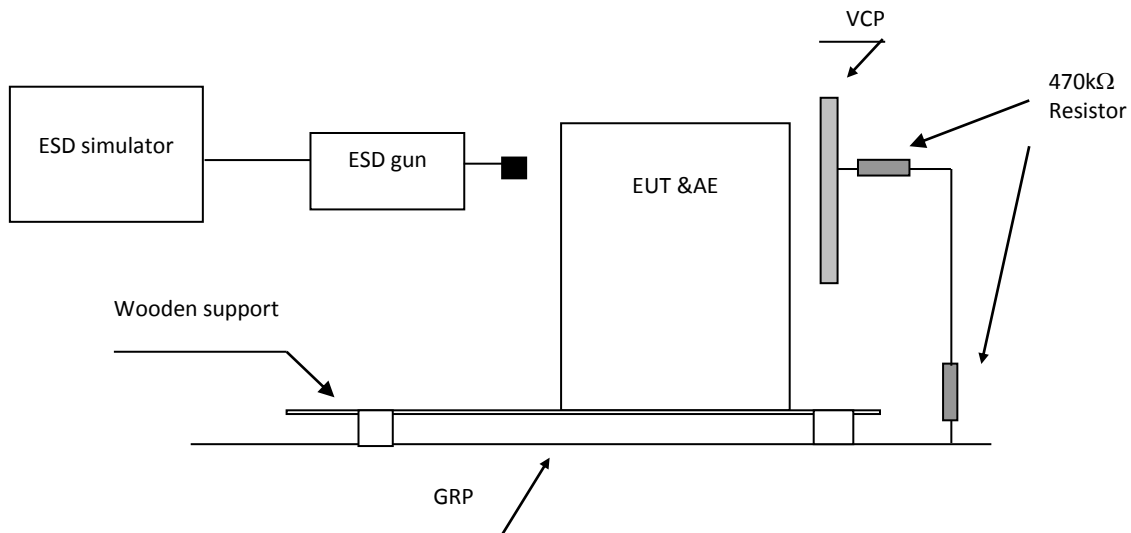

Note: VCP means Vertical Coupling Plane  
 GRP means Ground Reference Plane  
 Wooden support is a 0.1m height rack

### **9.3 Test Setup and Test Procedure**

Measurement was performed in shielded room.

Measurement and setting of EUT was applied according to IEC 61000-4-2 Clause 7.

The test method and equipment was specified by IEC 61000-4-2 with the modifications by EN 55014-2 clause 5.1.

## 9.4 Test Protocol

Direct discharges were applied at the following selected points:

Test point #	Test level [kV]	Air/Contact	Polarity (+/-)	Pass/Fail/NA	Comment
A	2/4	Contact	+/-	Pass	All touchable screws of enclosure
B	2/4	Contact	+/-	Pass	Accessible metal parts of the EUT
C	2/4/8	Air	+/-	Pass	Air gap of the switch, button
D	2/4/8	Air	+/-	Pass	The air in-taking opening
E	2/4/8	Air	+/-	Pass	Slots around the EUT

Indirect contact discharges were applied to the VCP and the HCP at the following selected points:

For table top equipment

Point	Description	Point	Pass/Fail/NA
HCP f	0,1m from the front of the EUT	Edge of centre, corner on HCP	-
HCP b	0,1m from the back of the EUT	Edge of centre, corner on HCP	-
HCP r	0,1m from the right side of the EUT	Edge of centre, corner on HCP	-
HCP l	0,1m from the left side of the EUT	Edge of centre, corner on HCP	-
VCP f	0,1m from the front of the EUT	Edge of centre, corner on VCP	-
VCP b	0,1m from the back of the EUT	Edge of centre, corner on VCP	-
VCP r	0,1m from the right of the EUT	Edge of centre, corner on VCP	-
VCP l	0,1m from the left of the EUT	Edge of centre, corner on VCP	-

For floor standing equipment

Point	Description	Point	Pass/Fail/NA
VCP f	0,1m from the front of the EUT	Edge of centre, corner on VCP	Pass
VCP b	0,1m from the back of the EUT	Edge of centre, corner on VCP	Pass
VCP r	0,1m from the right of the EUT	Edge of centre, corner on VCP	Pass
VCP l	0,1m from the left of the EUT	Edge of centre, corner on VCP	Pass

**Observation:** All the functions were operated as normal during and after test.

**Conclusion:** The EUT met the requirements of Performance Criterion B.

## 10. Electromagnetic field susceptibility

**Test result:** Pass

### 10.1 Severity Level and Performance Criterion

#### 10.1.1 Test level

Level	Test field strength V/m
1	1
2	3
3	10
X	Special
<b>Notes:</b> 1. X is an open test level. This level may be given in the product specification. 2. The gray row is the selected test level.	

#### 10.1.2 Performance Criterion

Performance criterion: **A**

### 10.2 Block diagram of test setup

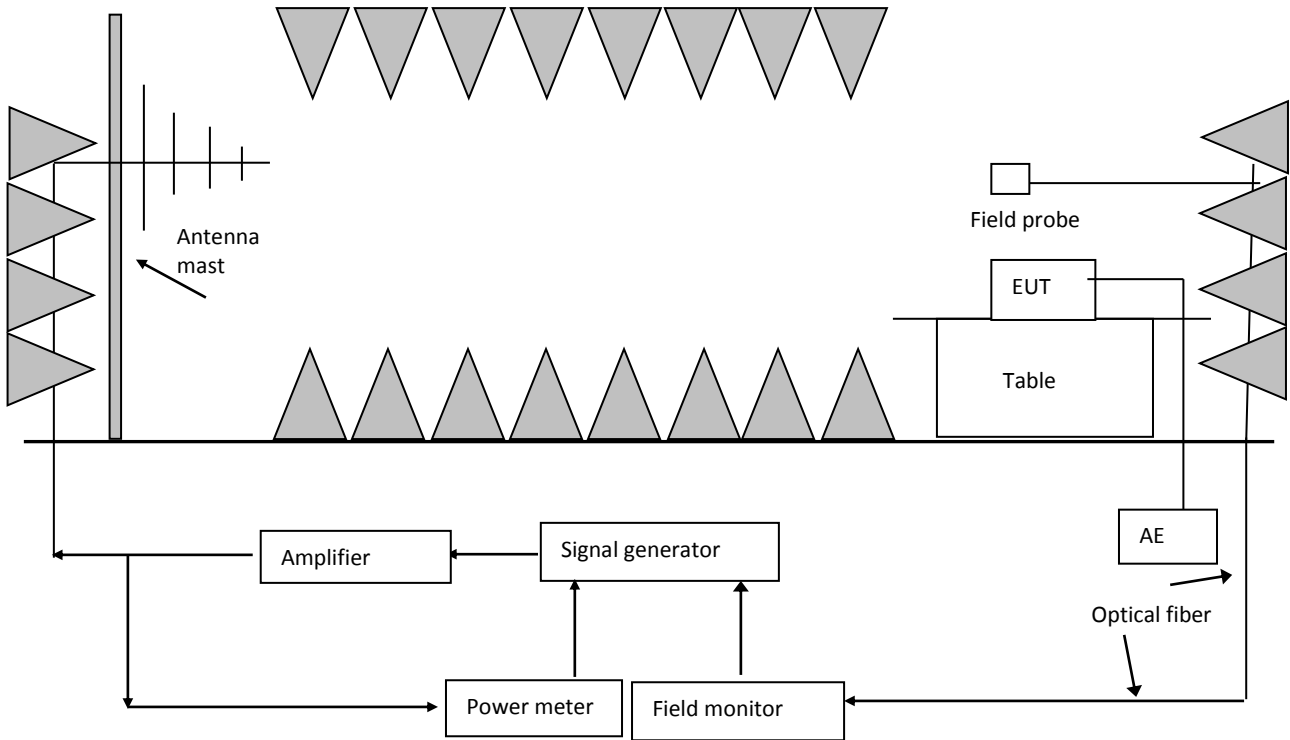

### 10.3 Test Setup and Test Procedure

Measurement was performed in full-anechoic chamber.

Measurement and setting of EUT was applied according to IEC 61000-4-3 clause 7.

The test method and equipment was specified by IEC 61000-4-3 with additions and modifications by EN 55014-2 clause 5.5.

### 10.4 Test Protocol

Test no.:	Frequency (MHz)	Polarization	Test level V/m	Modulation	Exposed location	Pass/Fail/NA	Comment
1	80-1000	H & V	3	1kHz, 80%, SW, AM, 1% step size	All sides	Pass	-

**Observation:** All the functions were operated as normal during and after test.

**Conclusion:** The EUT met the requirements of Performance Criterion A.

## 11. Electric Fast Transient/Burst Immunity Test

Test result: **PASS**

### 11.1 Severity Level and Performance Criterion

#### 11.1.1 Test level

Open circuit output test voltage ( $\pm 10\%$ ) and repetition rate of the impulses ( $\pm 20\%$ )				
Level	Input and output a.c. power ports		Input and output d.c. power ports Signal lines and control lines ports	
	Voltage peak kV	Repetition rate kHz	Voltage peak kV	Repetition rate kHz
1	0.5	5	0.25	5
2	1	5	0.5	5
3	2	5	1	5
4	4	5	2	5
X	Special	Special	Special	Special

Notes :

1. "X" is an open level. The level has to be specified in the dedicated equipment specification.
2. The gray rows were the selected test level.

#### 11.1.2 Performance Criterion

Performance criterion **B**

### 11.2 Block Diagram of Test Setup

#### 11.2.1 Block Diagram for input a.c./d.c. power line

For table-top equipment

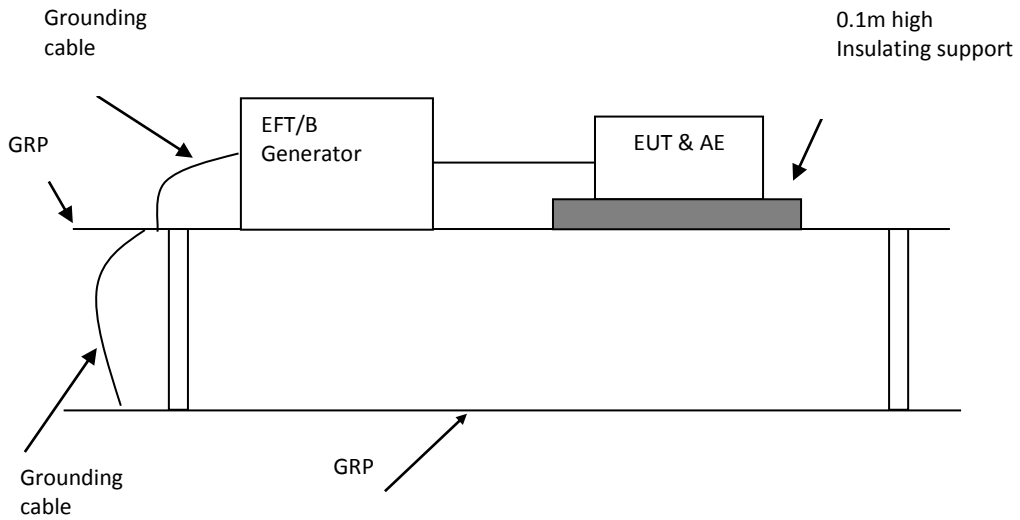

For floor standing equipment

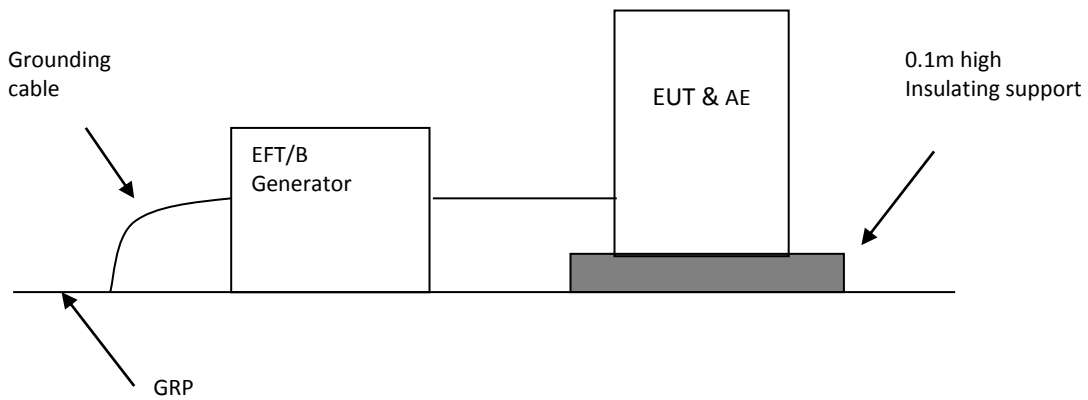



### 11.2.2 Block Diagram for output a.c./d.c. power line or signal/control lines

For table-top equipment

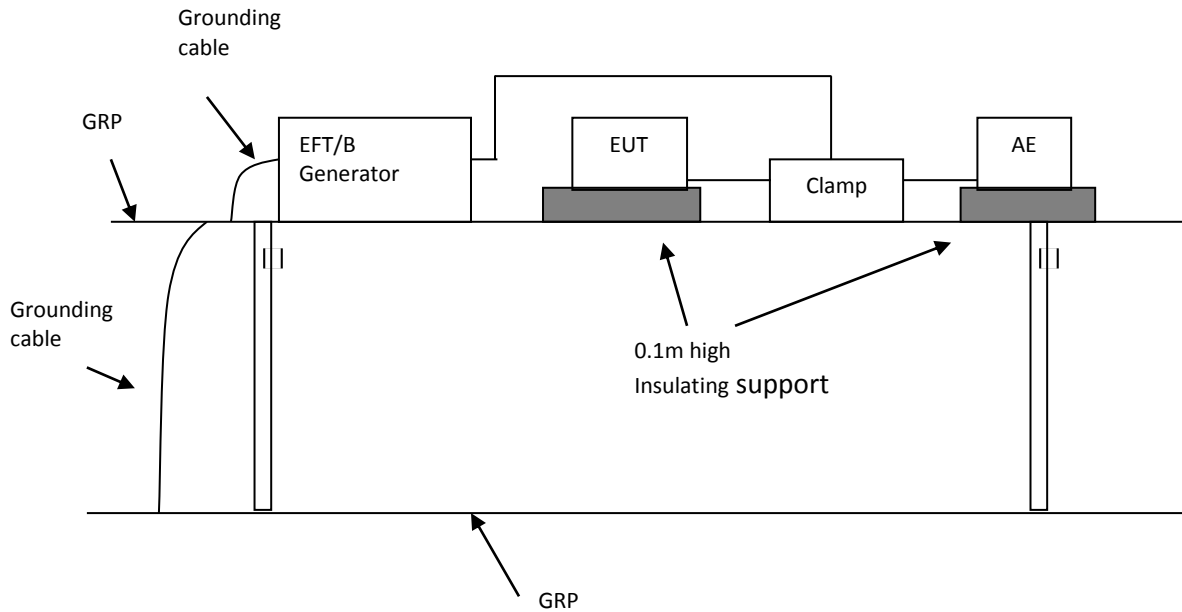

For floor standing equipment

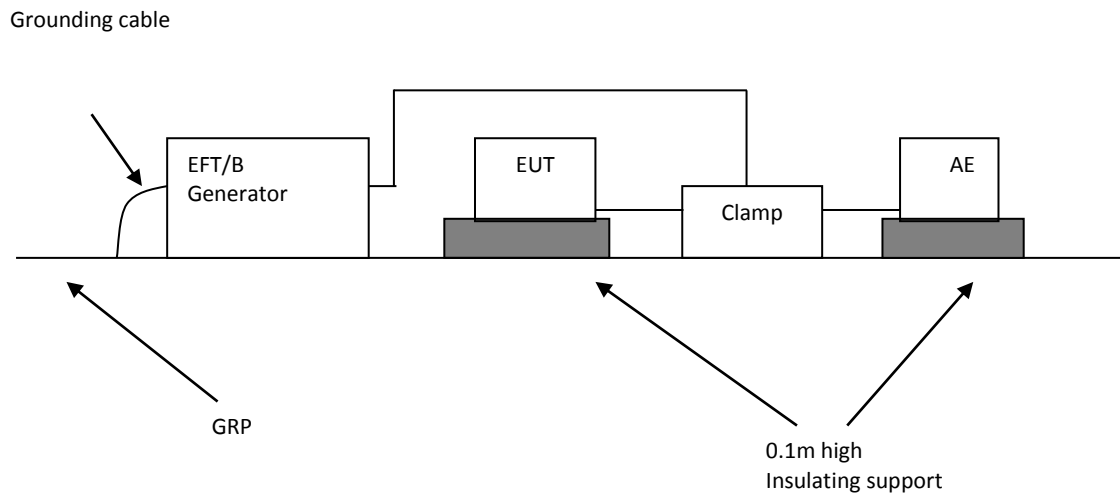

### 11.3 Test Setup and Test Procedure

Measurement was performed in shielded room.

Measurement and setting of EUT was applied according to IEC 61000-4-4 clause 7.

The test method and equipment was specified by IEC 61000-4-4 with additions and modifications by EN 55014-2 clause 5.2.

**11.4 Test Protocol**

Test No.	Level [kV]	Polarity +/-	Repetition rate kHz	Line for test	Pass/Fail/NA
1	1	+/-	5	a.c. power ports	Pass
2	0.5	+/-	5	d.c. power ports	NA
3	0.5	+/-	5	Signal lines and control lines	NA

**Observation:** All the functions were operated as normal during and after test.

**Conclusion:** The EUT met the requirements of Performance Criterion B.

## 12. Surge Immunity Test

Test result: **PASS**

### 12.1 Severity Level and Performance Criterion

#### 12.1.1 Test level

Level	Open-circuit test voltage $\pm 10\%$ kV
1	0.5
2	1.0
3	2.0
4	4.0
X*	Special

Notes:

- "X" is an open class. This level can be specified in the product Specification
- The gray rows are the selected level.

#### 12.1.2 Performance Criterion

Performance criterion **B**

## 12.2 Block Diagram of Test Setup

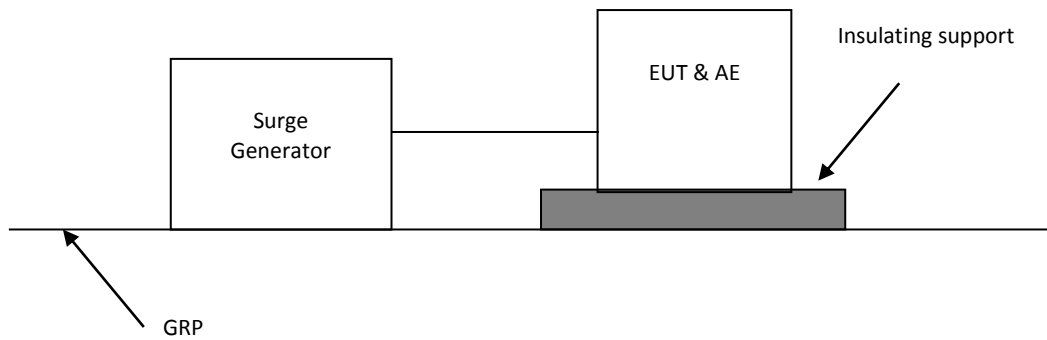

## 12.3 Test Setup and Test Procedure

Measurement was performed in shielded room.

Measurement and setting of EUT was applied according to IEC 61000-4-5 clause 7.

The test method and equipment was specified by IEC 61000-4-5 with modifications by EN 55014-2 clause 5.6.

## 12.4 Test Protocol

Test No.	Level [kV]	Polarity +/-	Angle	Line for test	Pass/Fail/NA
1	1	+	90 <sup>0</sup>	a.c. Mains (line to earth)	NA
2	1	-	270 <sup>0</sup>	a.c. Mains (line to earth)	NA
3	1	+	90 <sup>0</sup>	a.c. Mains (line to line)	Pass
4	1	-	270 <sup>0</sup>	a.c. Mains (line to line)	Pass
5	2	+	90 <sup>0</sup>	a.c. Mains (line to earth)	NA
6	2	-	270 <sup>0</sup>	a.c. Mains (line to earth)	NA

**Observation:** All the functions were operated as normal during and after test.

**Conclusion:** The EUT met the requirements of Performance Criterion B.

### 13. Immunity to Conducted Disturbances, Induced by Radio-frequency Fields

**Test result: PASS**

#### 13.1 Severity Level and Performance Criterion

##### 13.1.1 Test level

Frequency range 150kHz – 80MHz		
Level	Voltage level (e.m.f.)	
	$U_0$ [dB( $\mu$ V)]	$U_0$ (V)
1	120	1
2	130	3
3	140	10
X	Special	Special

Notes:

1. "X" is an open level.
2. The gray row is the selected test level.

##### 13.1.2 Performance Criterion

Performance criterion: **A**

#### 13.2 Block Diagram of Test Setup

##### 13.2.1 Block Diagram for a.c./d.c input power line

Block Diagram for a.c./d.c input power line

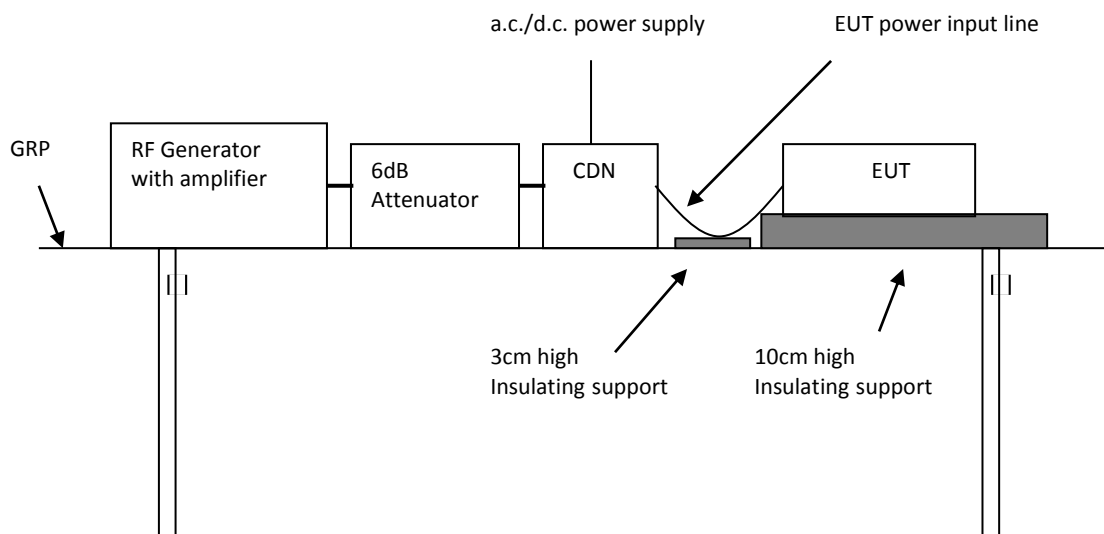

### 13.2.2 Block Diagram for output a.c./d.c. power line or signal/control lines

Unshielded line

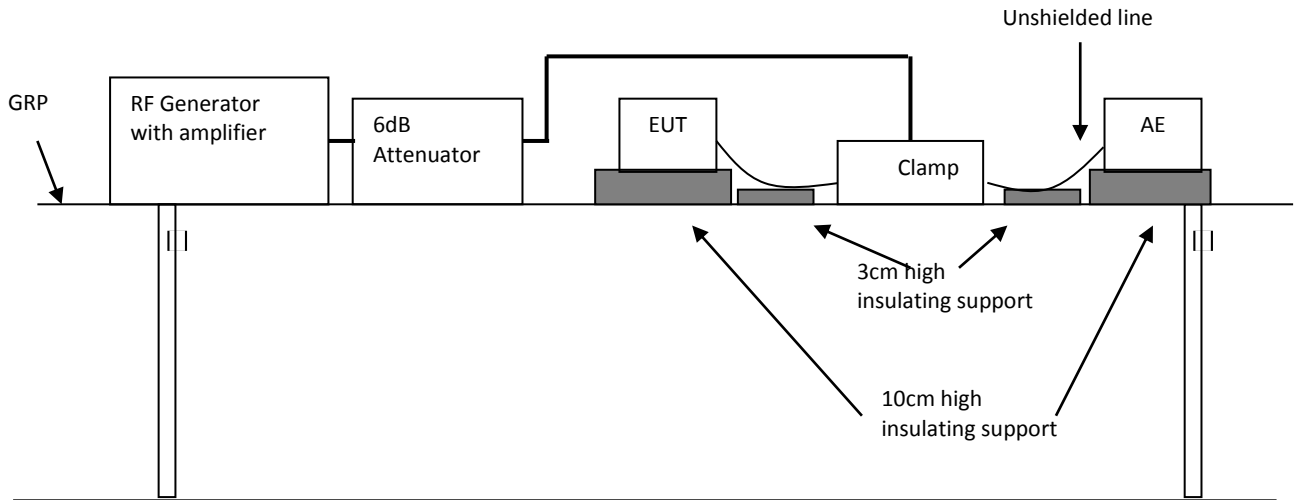

Shielded line

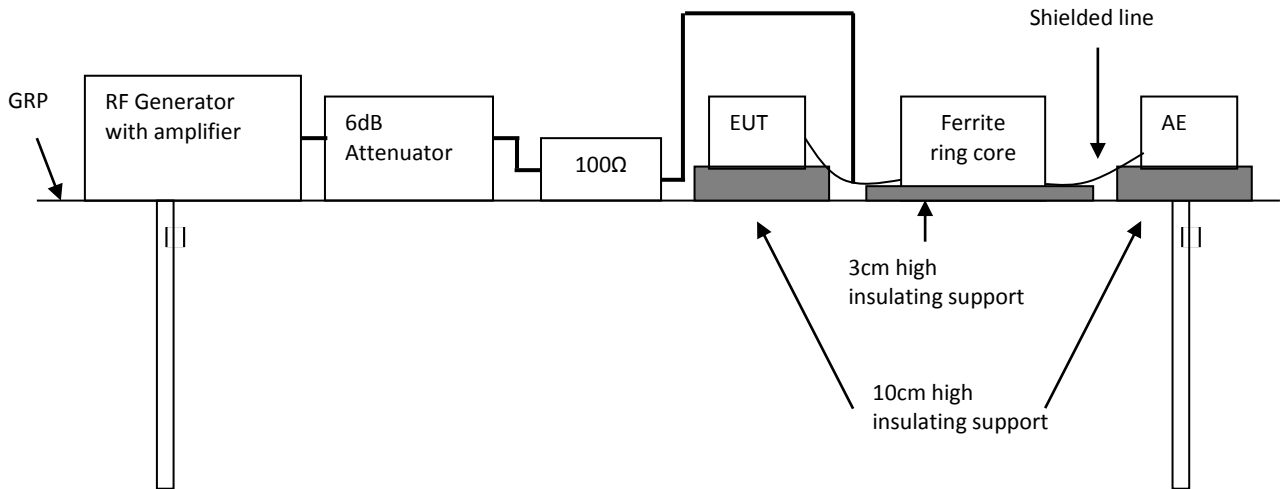

### 13.3 Test Setup and Test Procedure

Measurement was performed in shielded room.

Measurement and setting of EUT was applied according to IEC 61000-4-6 clause 7.

The test method and equipment was specified by IEC 61000-4-6 with additions and modifications by EN 55014-2 clause 5.3, 5.4.

### 13.4 Test Protocol

EUT is not required for electromagnetic susceptibility

Test No.	Frequency (MHz)	Level V (r.m.s.)	Modulation	Injected point	Pass/Fail/NA
1	0.15~230	3	1kHz, 80%, SW, AM, 1% step size	a.c. power ports	Pass
2	0.15~230	1	1kHz, 80%, SW, AM, 1% step size	d.c. power ports	-
3	0.15~230	1	1kHz, 80%, SW, AM, 1% step size	signal lines and control lines	-

For EUT test Electromagnetic field susceptibility

Test No.	Frequency (MHz)	Level V (r.m.s.)	Modulation	Injected point	Pass/Fail/NA
1	0.15~80	3	1kHz, 80%, SW, AM, 1% step size	a.c. power ports	NA
2	0.15~80	1	1kHz, 80%, SW, AM, 1% step size	d.c. power ports	-
3	0.15~80	1	1kHz, 80%, SW, AM, 1% step size	signal lines and control lines	-

**Observation:** All the functions were operated as normal during and after test.

**Conclusion:** The EUT met the requirements of Performance Criterion A.

## 14. Voltage Dips, Short Interruptions and Voltage Variations Immunity Test

**Test result: PASS**

### 14.1 Severity Level and Performance Criterion

#### 14.1.1 Test level

Test level % U <sub>T</sub>	Voltage dip and short interruptions % U <sub>T</sub>	Duration (in period)	
		50Hz	60Hz
0	100	0.5 cycle	0.5 cycle
40	60	10 cycles	12 cycles
70	30	25 cycles	30 cycles

Notes:

1. "\*" for 0.5 period, the test shall be made in positive and negative polarity, i.e. starting at 0° and 180°, respectively.
2. "\*\*\*" means "x" is an open duration. This duration can be given in the product specification. Utilities in Europe have measured dips and short interruptions of duration between ½ a period and 3000 periods, but duration less than 50 periods are most common.
3. If the EUT is tested for voltage dips of 100%, it is generally unnecessary to test for other levels for the same durations. However, for some cases (safeguard systems or electro-mechanical devices) it is not true. The product specification or product committee shall give an indication of the applicability of this note.
4. The gray rows are selected test level.

#### 14.1.2 Performance Criterion

Performance criterion: **C**



### 14.2 Block diagram of test setup

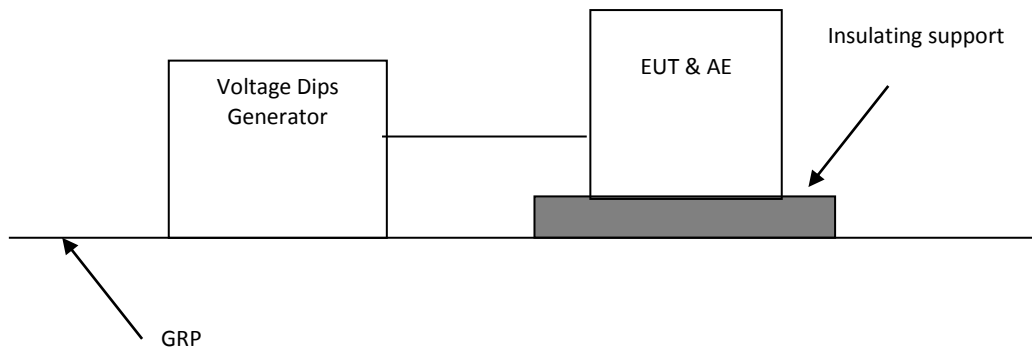

### 14.3 Test Setup and Test Procedure

Measurement was performed in shielded room.

Measurement and setting of EUT was applied according to IEC 61000-4-11 clause 7.

The test method and equipment was specified by IEC 61000-4-11 with additions and modifications by EN 55014-2 clause 5.7.

### 14.4 Test Protocol

Test no.	% U <sub>T</sub>	Voltage dip and short interruptions % U <sub>T</sub>	Duration (in periods)	Pass/Fail/NA
1	70	30%	25 cycles at 50Hz	Pass
			30 cycles at 60Hz	
2	40	60%	10 cycles at 50Hz	Pass
			12 cycles at 60Hz	
3	0	100% pos half cycle	0.5 cycle at 50Hz	Pass
			0.5 cycle at 60Hz	
4	0	100% neg half cycle	0.5 cycle at 50Hz	Pass
			0.5 cycle at 60Hz	

**Observation:** At test level of 70%, the EUT worked unsteadily. Once the interference is removed, it recovered its normal mode at once

**Conclusion:** The EUT met the requirements of Performance Criterion B.

**Appendix I: Photograph of equipment under test**



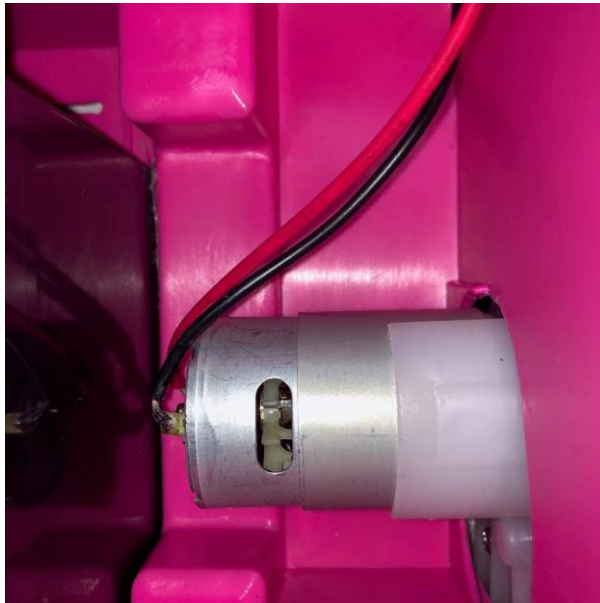



\*\*\*END of the report\*\*\*